

Fig. 4

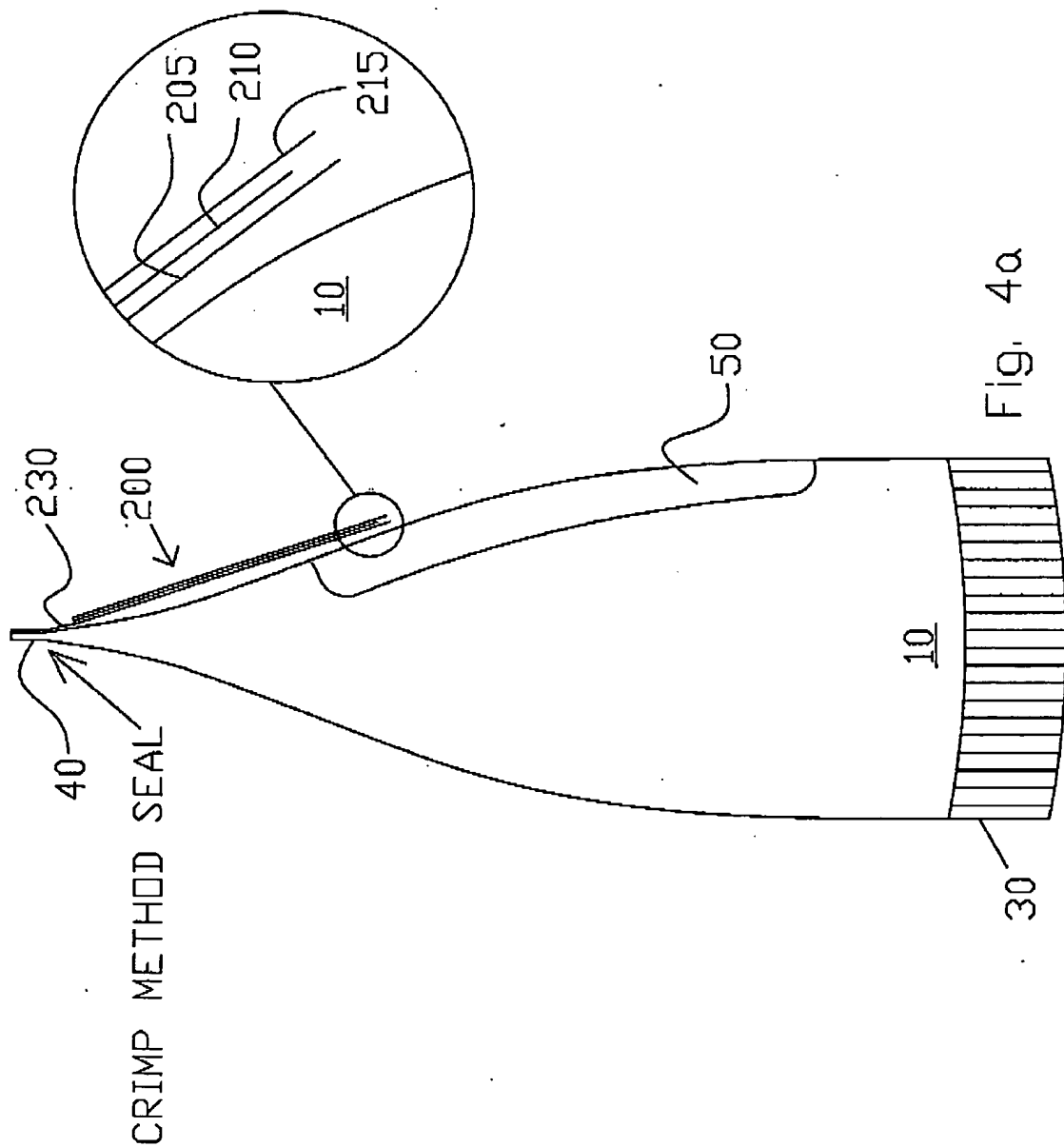

FIG. 4a